

Doorsteekanker FAZ / FAZ II



Gebruik

Goedgekeurd voor:

- Gescheurd en ongescheurd beton C20/25 tot C50/60 (B25/B55)

Tevens geschikt voor:

- Beton C12/15 (B15)
- Natuursteen met hoge dichtheid

Ter bevestiging van:

- Stalen constructies
- Railingen
- Consoles
- Ladders
- Kabelgoten
- Machines

- Trappen
- Hekwerk
- Gevelsystemen
- Houten constructies

Omschrijving

- Ankerbout voor door- en voorsteekmontage.
- Wanneer de moer wordt aangedraaid, wordt de conus in de expansieclip getrokken welke zich vervolgens tegen de boorwand klemt.
- De FAZ II A4 gemaakt van roestvast staal met corrosieweerstandsklasse III, voor toepassingen buitenshuis en onder vochtige condities. Hoog corrosiewerend staal C, corrosieweerstandsklasse IV voor toepassingen in hoog corrosieve omgevingen.
- FAZ II-GS met grote voorgemonteerde onderlegging voor de bevestiging in een slobgat.

Voordelen

- Geoptimaliseerde expansieclip garandeert uniforme krachtenafdracht voor hoge toelaatbare belastingen en korte h.o.h.- en randafstanden van constructieve elementen, evenals veilige uitzetting, zelfs in gescheurd beton.
- Zeer gemakkelijke en snelle montage, er zijn slechts een paar slagen nodig om het gewenste aandraaimoment te verkrijgen.

Montage voorbeeld





Montage

Type van montage

- Voorsteek- en doorsteekmontage

Montage tips

- Voor seriemontage bevelen wij het machinale montagehulpstuk FABS aan ter vermindering van de montagetijd.
- Voor montage, dient de moer in de juiste positie gebracht te worden (de bout steekt 2-3 mm uit).

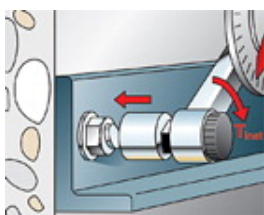
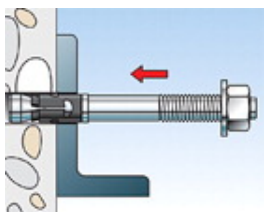
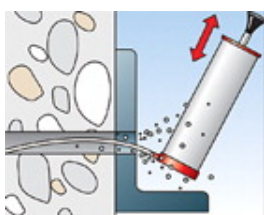
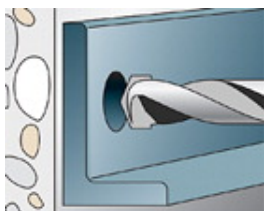

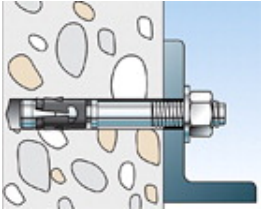

Technische gegevens

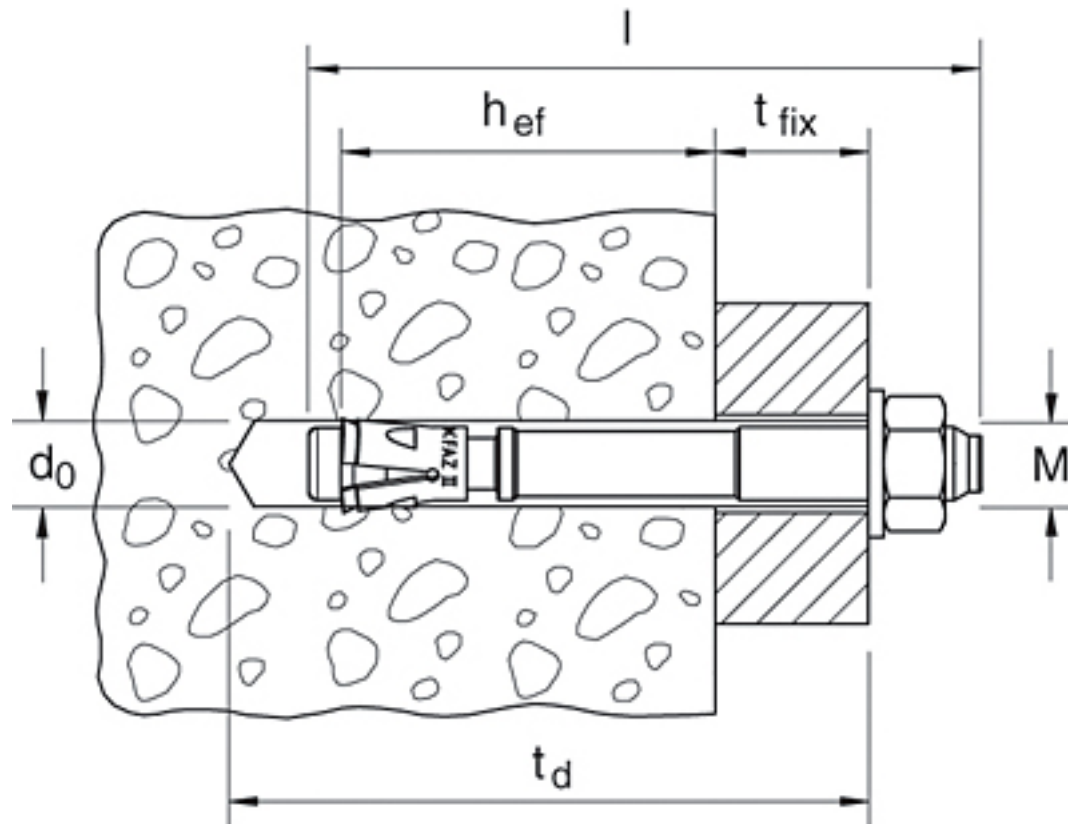



Elektrolytisch verzinkt

Type	Art.-Nr.	<input type="checkbox"/> ETA <input type="checkbox"/> DIBt	Markering in kop	Boor-Ø d_0 [mm]	Min. boorgatdiepte bij doorsteekmontage t_d [mm]	Min. verankeringsdiepte h_{ef} [mm]	Pluglengte l [mm]	Max. nuttige lengte t_{fix} [mm]	Draad M	Sleutelwijdte
FAZ II 8/10	094871		(B)	8	65	45	75	10	M 8	13
FAZ II 8/30	094877		(F)	8	85	45	95	30	M 8	13
FAZ II 8/50	094878		(K)	8	105	45	115	50	M 8	13

Type	Art.-Nr.	<div style="display: flex; align-items: center; gap: 5px;"> ■ ETA ● DIBt </div>	Markering in kop	Boor-Ø d _o [mm]	Min. boorgatdiepte bij doorsteekmontage t _d [mm]	Min. verankeringsdiepte h _{ef} [mm]	Pluglengte l [mm]	Max. nuttige lengte t _{fix} [mm]	Draad M	Sleutelwijdte
FAZ II 8/100	094879		(P)	8	155	45	165	100	M 8	13
FAZ II 8/160	503251		(T)	8	215	45	225	160	M 8	13
FAZ II 10/10	094981		(B)	10	85	60	95	10	M 10	17
FAZ II 10/20	094982		(D)	10	95	60	105	20	M 10	17
FAZ II 10/30	094983		(F)	10	105	60	115	30	M 10	17
FAZ II 10/50	094984		(K)	10	125	60	135	50	M 10	17
FAZ II 10/80	094985		(N)	10	155	60	165	80	M 10	17
FAZ II 10/100	094986		(P)	10	175	60	185	100	M 10	17
FAZ II 10/160	503252		(T)	10	235	60	245	160	M 10	17
FAZ II 12/10	095419		(B)	12	100	70	110	10	M 12	19
FAZ II 12/20	095420		(D)	12	110	70	120	20	M 12	19
FAZ II 12/30	095421		(F)	12	120	70	130	30	M 12	19
FAZ II 12/50	095446		(K)	12	140	70	150	50	M 12	19
FAZ II 12/80	095454		(N)	12	170	70	180	80	M 12	19
FAZ II 12/100	095470		(P)	12	190	70	200	100	M 12	19
FAZ II 12/160	503253		(T)	12	250	70	260	160	M 12	19
FAZ II 12/200	095605		(V)	12	290	70	300	200	M 12	19
FAZ II 16/25	095836		(E)	16	135	85	148	25	M 16	24
FAZ II 16/50	095864		(K)	16	160	85	173	50	M 16	24
FAZ II 16/100	095865		(P)	16	210	85	223	100	M 16	24
FAZ II 16/160	503254		(T)	16	270	85	283	160	M 16	24
FAZ II 16/200	095967		(V)	16	315	85	323	200	M 16	24
FAZ II 16/250	095968		(W)	16	365	85	373	250	M 16	24
FAZ II 16/300	096188		(X)	16	410	85	423	300	M 16	24
FAZ II 20/30	046632		(F)	20	155	100	172	30	M 20	30
FAZ II 20/60	046633		(L)	20	185	100	202	60	M 20	30
FAZ II 20/160	503255		(T)	20	285	100	302	160	M 20	30
FAZ II 24/30	046635		(F)	24	185	125	205	30	M 24	36
FAZ II 24/60	046636		(L)	24	215	125	235	60	M 24	36

Type	Art.-Nr.	<div style="display: inline-block; width: 10px; height: 10px; background-color: blue; margin-right: 5px;"></div> ETA <div style="display: inline-block; width: 10px; height: 10px; background-color: red; border-radius: 50%; margin-right: 5px;"></div> DIBt	Markering in kop	Boor-Ø d _o [mm]	Min. boorgatdiepte bij doorsteekmontage t _d [mm]	Min. verankeringsdiepte h _{ef} [mm]	Pluglengte l [mm]	Max. nuttige lengte t _{fix} [mm]	Draad M	Sleutelwijdte
FAZ II 8/10 GS	094872		(B)	8	65	45	75	10	M 8 x 21	13
FAZ II 8/30 GS	096189		(F)	8	85	45	95	30	M 8 x 41	13
FAZ II 10/10 GS	096291		(B)	10	85	60	95	10	M 10 x 24	17
FAZ II 10/30 GS	096297		(F)	10	105	60	115	30	M 10 x 44	17
FAZ II 12/10 GS	096303		(B)	12	100	70	110	10	M 12 x 27	19
FAZ II 12/20 GS	502530		(D)	12	115	70	120	20	-	19
FAZ II 12/30 GS	096340		(F)	12	120	70	130	30	M 12 x 47	19
FAZ II 12/50 GS	502531		(K)	12	145	70	150	50	M 12 x 67	19
FAZ II 12/100 GS	502532		(P)	12	195	70	200	100	M 12 x 100	19
FAZ II 12/120 GS	096367		(R)	12	210	70	220	120	M 12 x 100	19
FAZ II 16/160 GS	503261		(T)	16	270	85	283	160	M 16 x 100	24
FAZ II 16/200 GS	096370		(V)	16	310	85	323	200	M 16 x 100	24

Hoog corrosiewerend staal, corrosieweerstandsklasse IV

Type	Art.-Nr.	 ETA  DIBt	Markering in kop	Boor-Ø d _o [mm]	Min. boorgatdiepte bij doorsteekmontage t _d [mm]	Min. verankeringsdiepte h _{ef} [mm]	Pluglengte l [mm]	Max. nuttige lengte t _{fix} [mm]	Draad M	Sleutelwijdte
FAZ II 8/10 C	501428		(B)	8	65	45	75	10	-	13
FAZ II 8/30 C	501429		(F)	8	85	45	95	30	-	13
FAZ II 10/10 C	501430		(B)	10	86	60	95	10	-	17
FAZ II 10/30 C	503185		(F)	10	105	60	115	30	-	17
FAZ II 12/10 C	503186		(B)	12	100	70	110	10	-	19
FAZ II 12/30 C	501431		(F)	12	120	70	130	30	-	19
FAZ II 16/25 C	501432		(E)	16	135	85	148	25	-	24
FAZ II 16/50 C	503187		(K)	16	160	85	173	50	-	24

Roestvast staal A4, corrosieweerstandsklasse III

Type	Art.-Nr.	<div style="display: flex; align-items: center; gap: 5px;"> ■ ETA ● DIBt </div>	Markering in kop	Boor-Ø d _o [mm]	Min. boorgatdiepte bij doorsteekmontage t _d [mm]	Min. verankeringdiepte h _{ef} [mm]	Pluglengte l [mm]	Max. nuttige lengte t _{fix} [mm]	Draad M	Sleutelwijdte
FAZ II 8/10 A4	501396		(B)	8	65	45	75	10	-	13
FAZ II 8/30 A4	501399		(F)	8	85	45	95	30	-	13
FAZ II 8/50 A4	501401		(K)	8	105	45	115	50	-	13
FAZ II 10/10 A4	501403		(B)	10	85	60	95	10	-	17
FAZ II 10/20 A4	501406		(D)	10	95	60	105	20	-	17
FAZ II 10/30 A4	501407		(F)	10	105	60	115	30	-	17
FAZ II 10/50 A4	501409		(K)	10	125	60	135	50	-	17
FAZ II 10/70 A4	501410		(M)	10	145	60	155	70	-	17
FAZ II 10/100 A4	501411		(P)	10	175	60	185	100	-	17
FAZ II 10/160 A4	501412		(T)	10	235	60	245	160	-	17
FAZ II 12/10 A4	501413		(B)	12	100	70	110	10	-	19
FAZ II 12/20 A4	501415		(D)	12	110	70	120	20	-	19
FAZ II 12/30 A4	501416		(F)	12	120	70	130	30	-	19
FAZ II 12/50 A4	501419		(K)	12	140	70	150	50	-	19
FAZ II 12/60 A4	501420		(L)	12	150	70	160	60	-	19
FAZ II 12/100 A4	501421		(P)	12	190	70	200	100	-	19
FAZ II 12/160 A4	503180		(T)	12	250	70	260	160	-	19
FAZ II 16/25 A4	501423		(E)	16	135	85	148	25	-	24

Type	Art.-Nr.	<div style="display: inline-block; width: 10px; height: 10px; background-color: blue; margin-right: 5px;"></div> ETA <div style="display: inline-block; width: 10px; height: 10px; background-color: red; border-radius: 50%; margin-right: 5px;"></div> DIBt	Markering in kop	Boor-Ø d _o [mm]	Min. boorgatdiepte bij doorsteekmontage t _d [mm]	Min. verankeringsdiepte h _{ef} [mm]	Pluglengte l [mm]	Max. nuttige lengte t _{fix} [mm]	Draad M	Sleutelwijdte
FAZ II 16/50 A4	501424		(K)	16	160	85	173	50	-	24
FAZ II 16/100 A4	501425		(P)	16	210	85	223	100	-	24
FAZ II 20/30 A4	501426		(F)	20	155	100	172	30	-	30
FAZ II 20/60 A4	503183		(L)	20	185	100	202	60	-	30
FAZ II 24/30 A4	501427		(F)	24	185	125	205	30	-	36
FAZ II 24/60 A4	503184		(L)	24	215	125	235	60	-	36
FAZ II 8/10 GS A4	501398		(B)	8	65	45	75	10	-	13
FAZ II 8/30 GS A4	501400		(F)	8	85	45	95	30	-	13
FAZ II 10/10 GS A4	501405		(B)	10	85	60	95	10	-	17
FAZ II 10/30 GS A4	501408		(F)	10	105	60	115	30	-	17
FAZ II 12/10 GS A4	501414		(B)	12	100	70	110	10	-	19
FAZ II 12/30 GS A4	501418		(F)	12	120	70	130	30	-	19
FAZ II 12/160 GS A4	503181		(T)	12	250	70	260	160	-	19
FAZ II 16/160 GS A4	503182		(T)	16	270	85	283	160	-	24
FAZ II 10/10 A4 E	091545	-	-	10	90	60	93	10	M 10	17
FAZ II 12/10 A4 E	091546	-	-	12	115	70	108	10	M 12	19
FAZ 10/70 A4	096796		-	10	150	60	153	70	M 10	17